

Cómoda Valentina

5 cajones

Instrucciones de montaje



Te aconsejamos

Ordena y cuenta las piezas y herrajes

Habilita una zona para el montaje

Utiliza la caja de embalaje desplegada como superficie de apoyo

No fuerces los tornillos y los elementos de montaje

Sigue paso a paso las instrucciones de montaje

Las herramientas que necesitas (no incluidas)

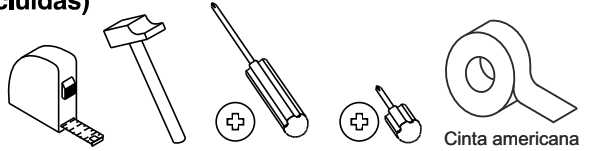

Cinta americana

Los herrajes que encontrarás en el kit

<p>Gm35 x 5</p> <p>Nº710254</p>	<p>Exc x 12</p> <p>Nº721116/721017</p>	<p>Lz x 1</p> <p>Nº710251</p>	<p>Aut x 4</p> <p>Nº710250</p>
<p>Tcp x 6</p> <p>Nº721308</p>	<p>Pun x 30</p> <p>Nº720006</p>	<p>Tirad x 8</p> <p>Nº722029</p>	<p>Tir x 17</p> <p>Nº721007</p>
<p>Pata x 4</p> <p>Nº710264</p>		<p>Pir x 3</p> <p>Nº721076</p>	<p>Rei x 16</p> <p>Nº721020</p>

Bolsa para los cajones (X5)

<p>Exc x 4</p> <p>Nº721126/721017</p>	<p>Aut x 4</p> <p>Nº710250</p>	<p>Rei x 4</p> <p>Nº721020</p>	<p>Eu x 4</p> <p>Nº721014</p>
---------------------------------------	--------------------------------	--------------------------------	-------------------------------

Las piezas incluidas en el kit



AVISO: este mueble puede contener piezas innecesarias para el montaje, pero necesarias para el embalaje.

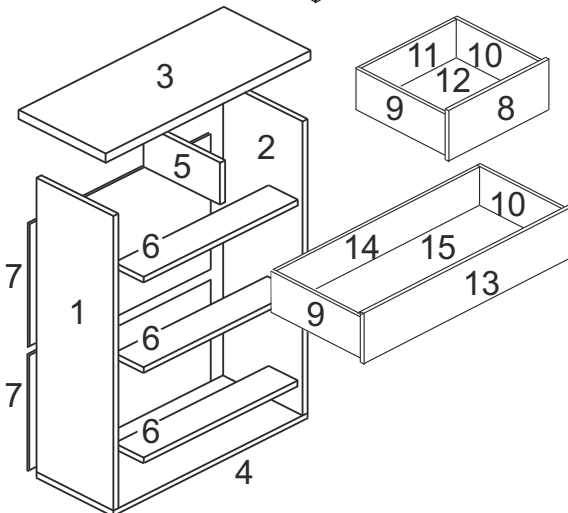

Las piezas incluidas en el kit

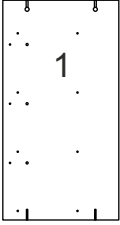

1
Lateral izquierdo
824x435 mm
903815

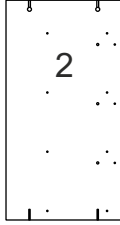

2
Lateral derecho
824x435 mm
903814

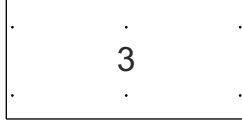

3
Techo
900x450 mm
903831



4
Suelo
872x436 mm
903832

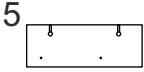

5
Pieza vertical
433x158 mm
903853

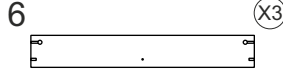

6
Pieza horizontal
838x120 mm
903850

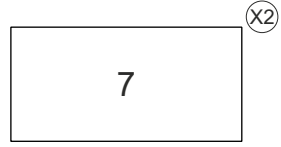

7
Trasera
866x428 mm
990385

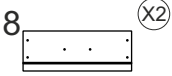

8
Frente cajón pequeño
407x150 mm
903862

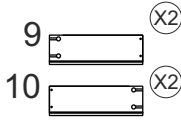

9
Costillas later
350x110 mm
1350115/1350116

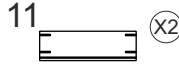

11
Costilla fondo
362x110 mm
1362119

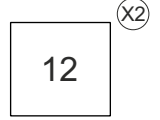

12
Fondo cajón pequeño
374x350 mm
890385

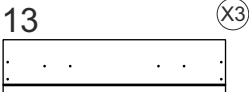

13
Frente cajón grande
834x199 mm
903861

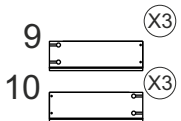

9
Costillas later
350x110 mm
1350115/1350116



14
Costilla fondo
789x110 mm
1789119



15
Fondo cajón grande
802x350 mm
890384

1

El primer paso es el montaje de los herrajes

Gm35 x 4

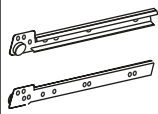

Eu x 16



Exc x 4



Exc x 6

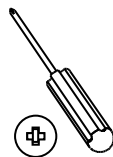
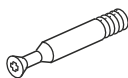

Bolsa para los cajones

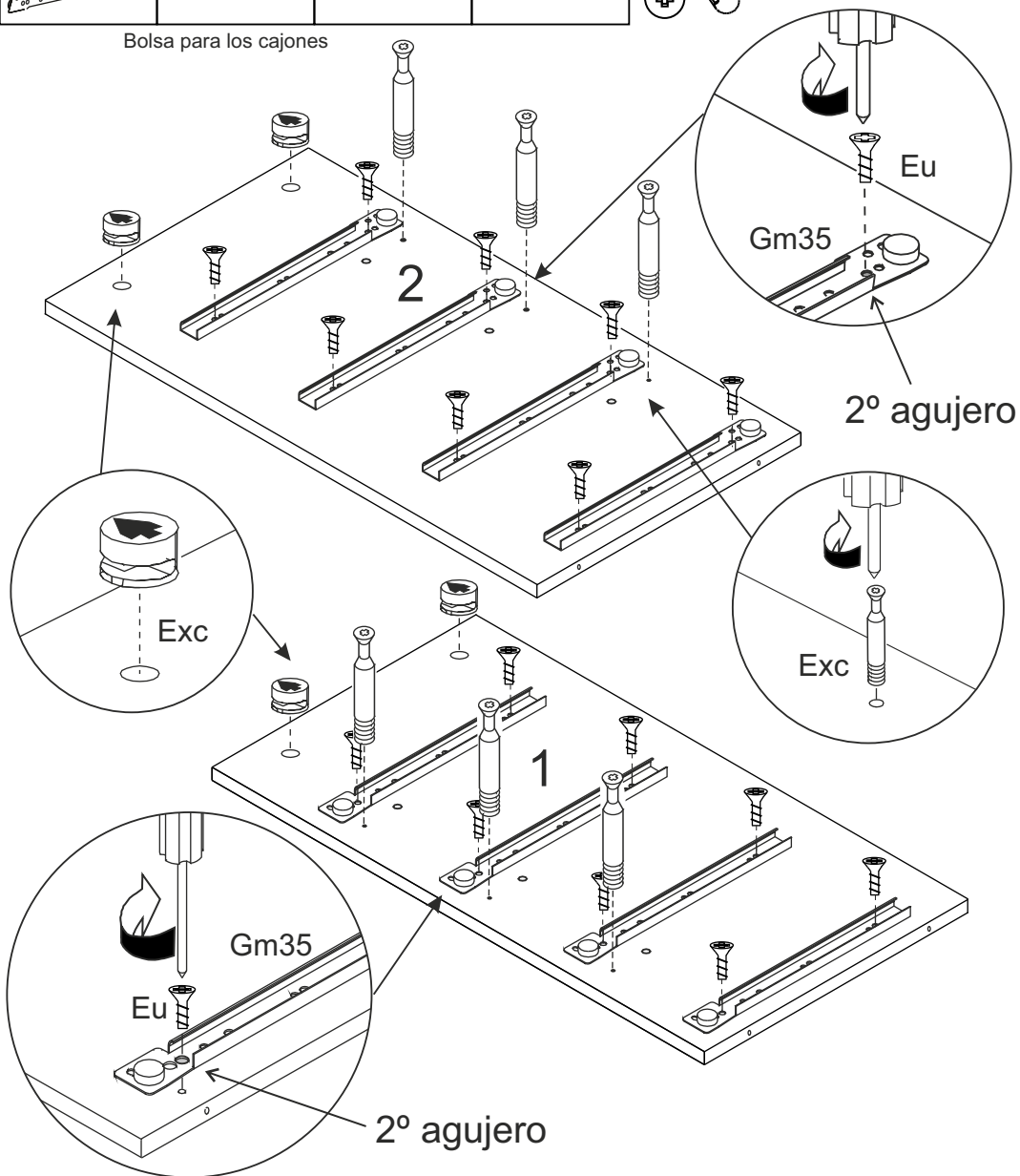

Gm35 x 1

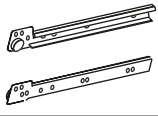

Eu x 4



Exc x 2

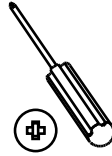

Bolsa para los cajones

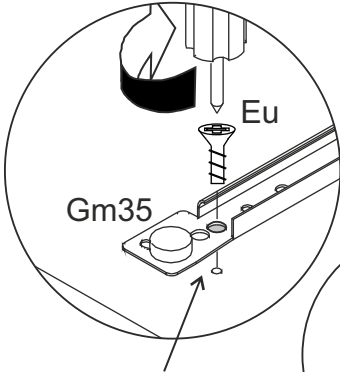

¡¡OJO!!
las excéntricas
pueden estar en
cualquiera de los
dos lados.
No importa.

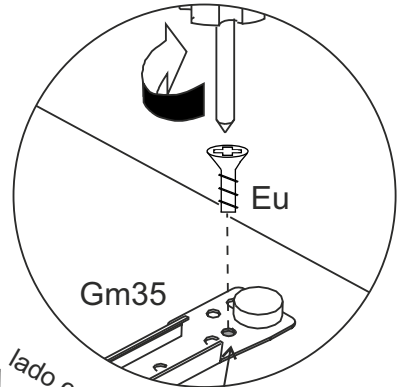

¡¡OJO!!
2º agujero

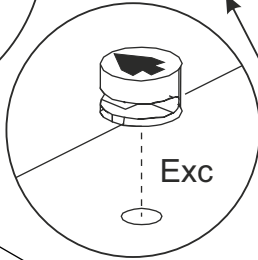

¡¡OJO!!
1º agujero

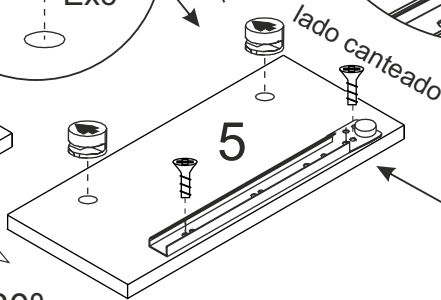
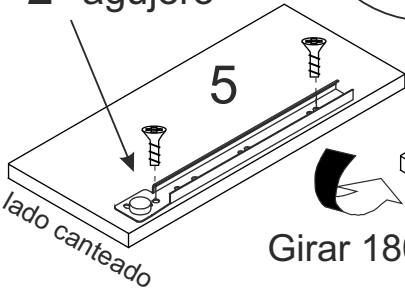

Girar 180°

Exc x 6



Tcp x 6

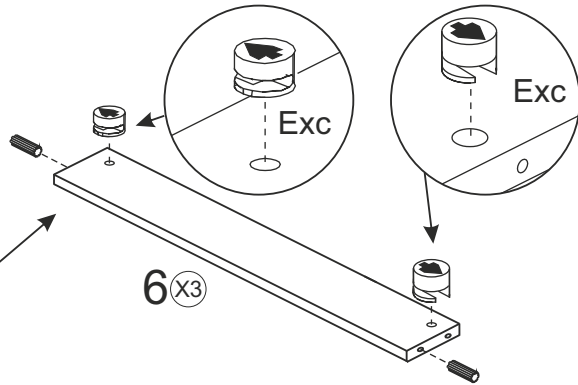
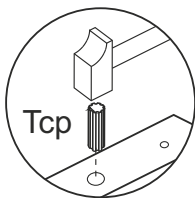
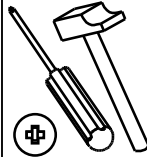
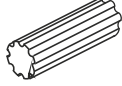

6 X3

Exc x 6

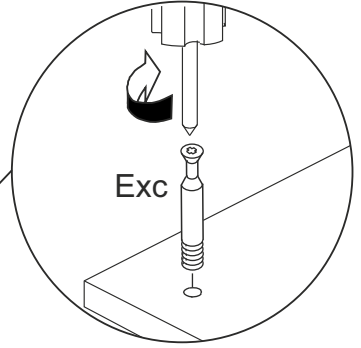
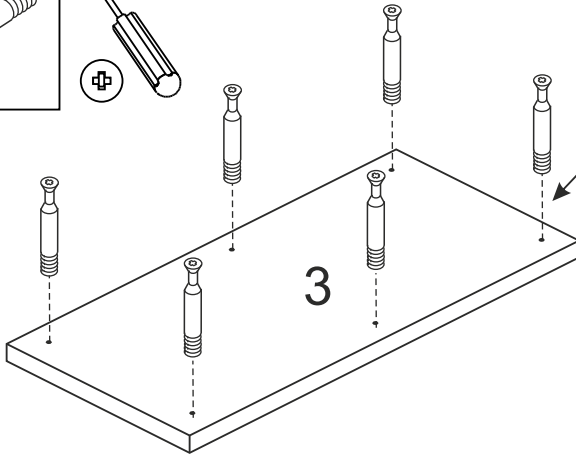
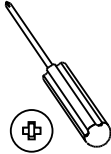
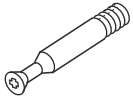

Exc

Exc x 20

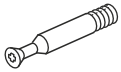

Tir x 16

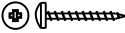

Tirad x 8

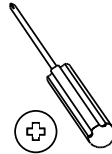

Bolsa para los cajones

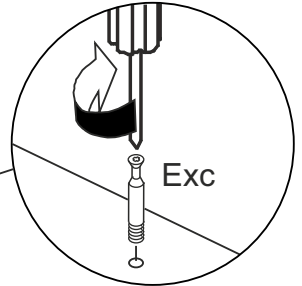
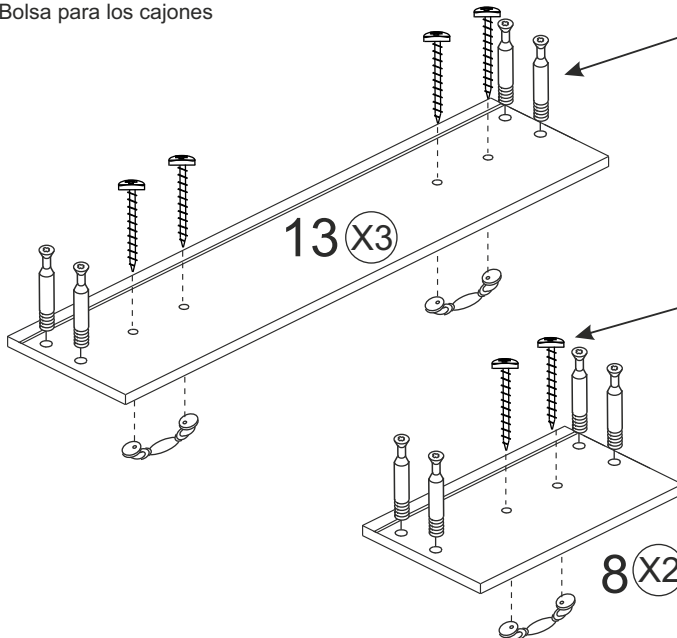

Exc

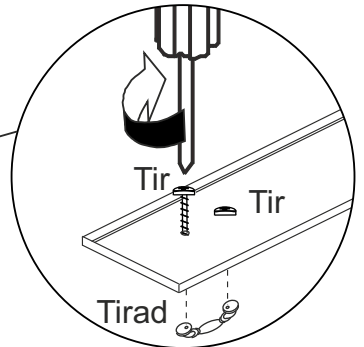

Tir

Tir

Tirad

Exc x 16

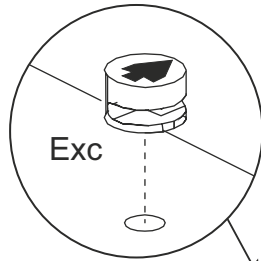
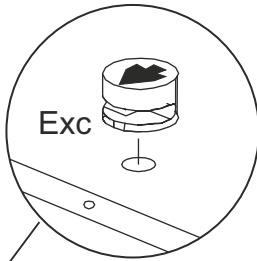
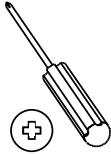

Bolsa para los cajones

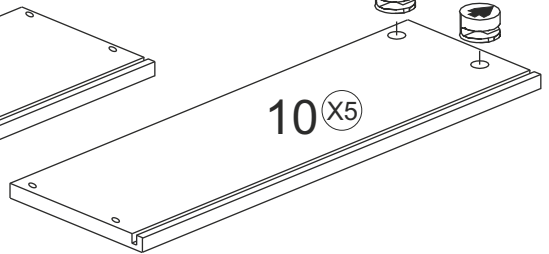
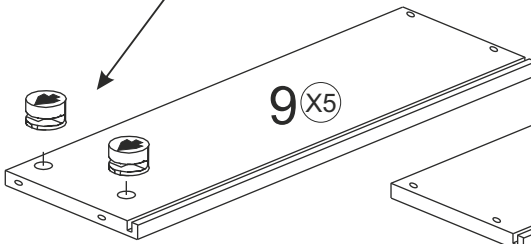

2

Gm35 x 2

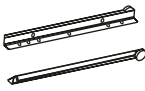

Rei x 8



Aut x 8



Lz x 1

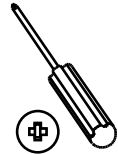
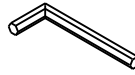

Bolsa para los cajones

Los 2 cajones se montan igual

10

Aut

Lz

9

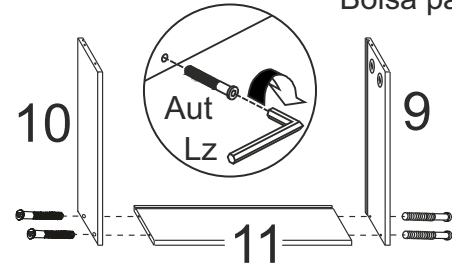

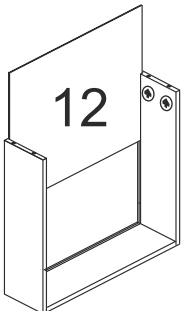

12

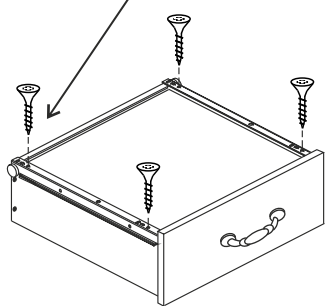
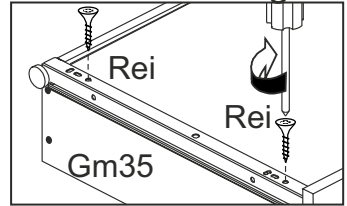
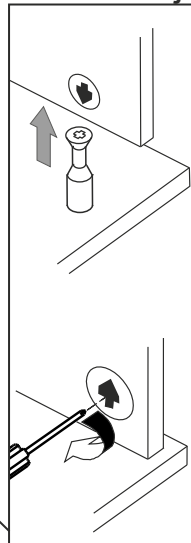
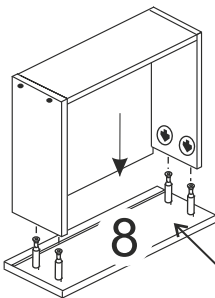

8

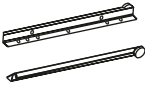

Cajón boca abajo

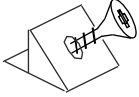
3	Gm35 x 3 	Rei x 12 	Aut x 12 	Pir x 3 
---	--	---	---	---

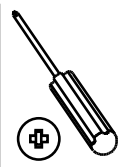

Bolsa para los cajones

Los 3 cajones se montan igual

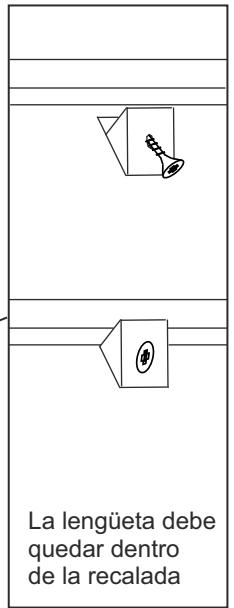
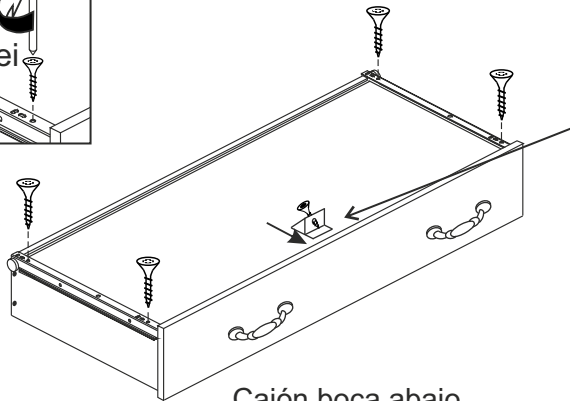
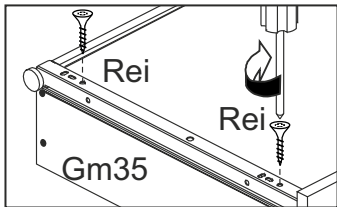
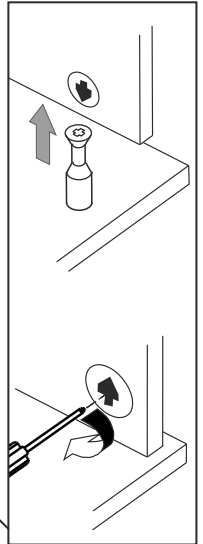
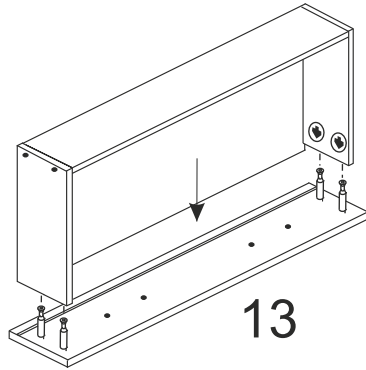
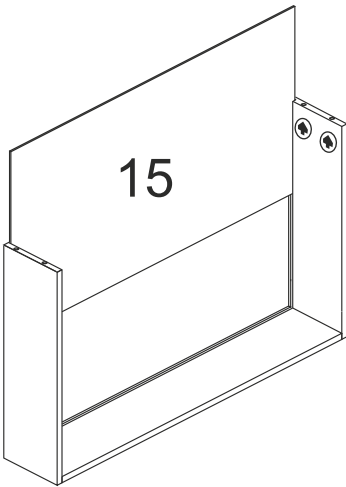
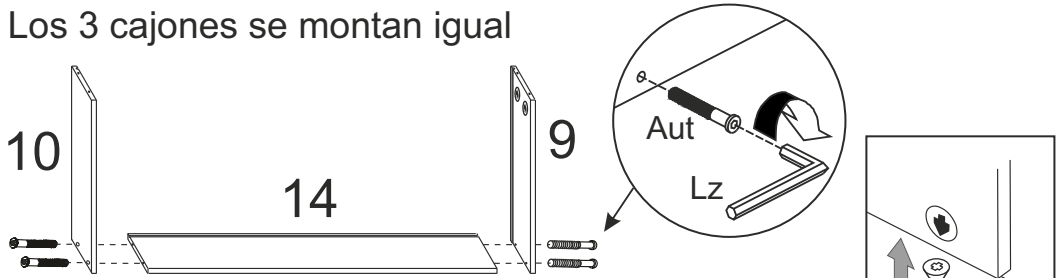

Cajón boca abajo

La lengüeta debe quedar dentro de la recalada

4

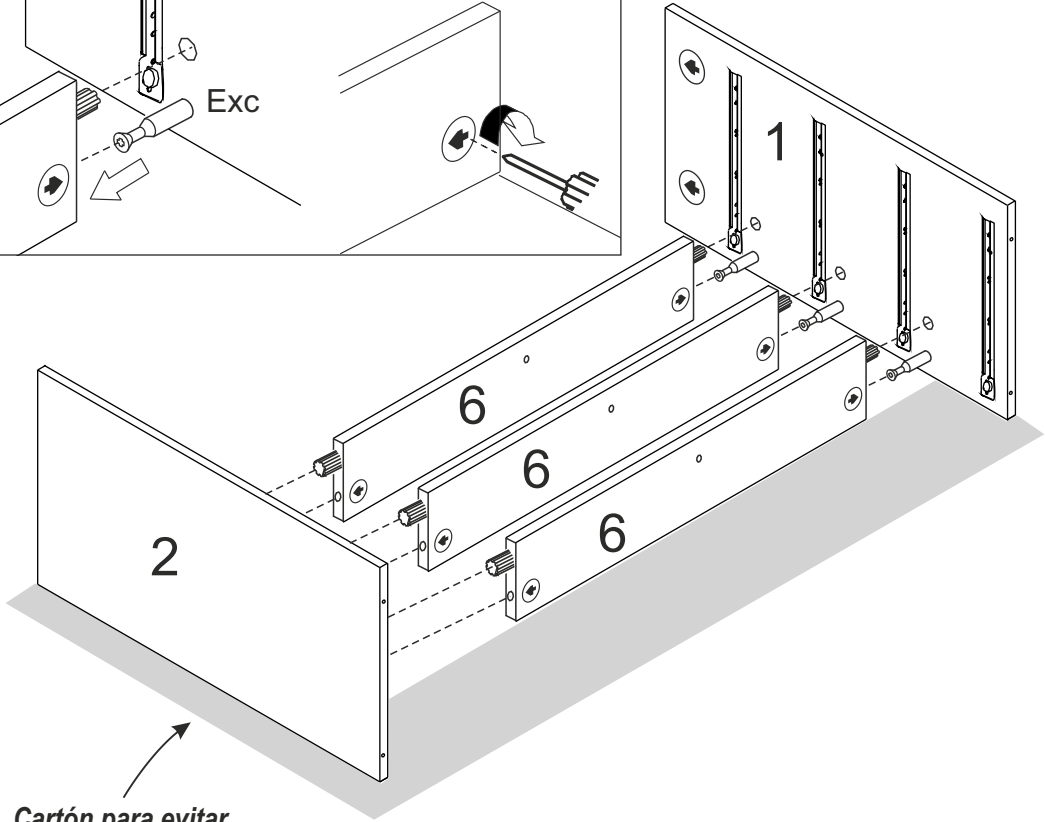
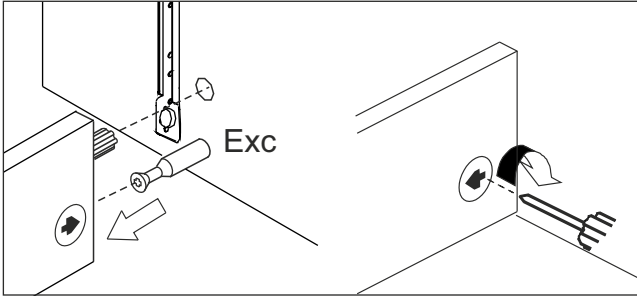
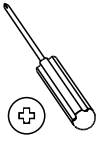

Cartón para evitar que el canto se estropee

5

Aut x 4



Lz x 1

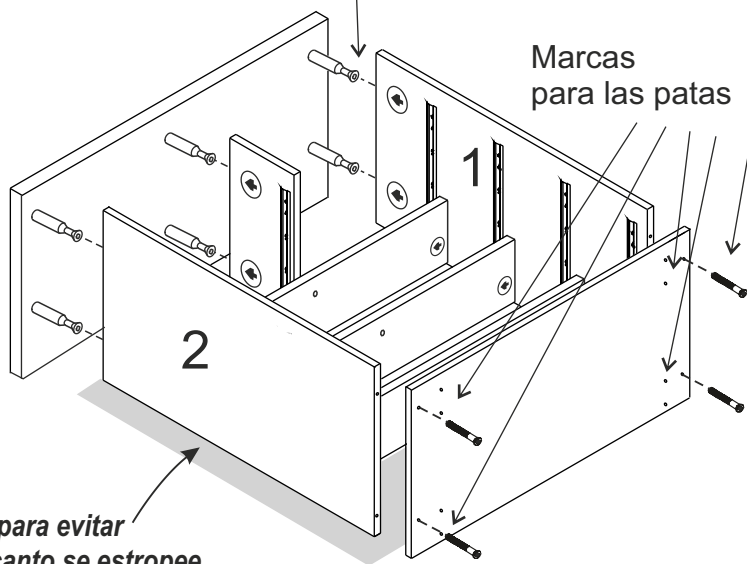
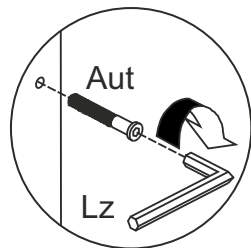
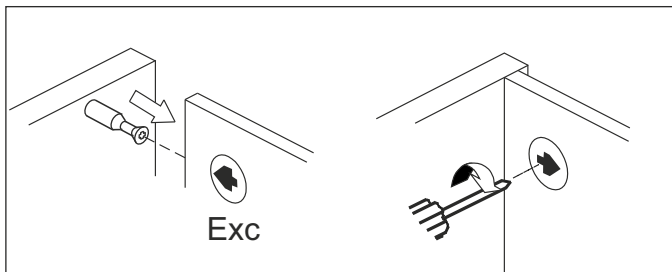
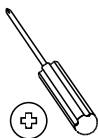
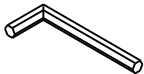

Cartón para evitar que el canto se estropee

6

Tir x 1

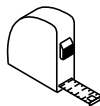
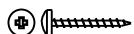

A y B deben medir igual (A=B)

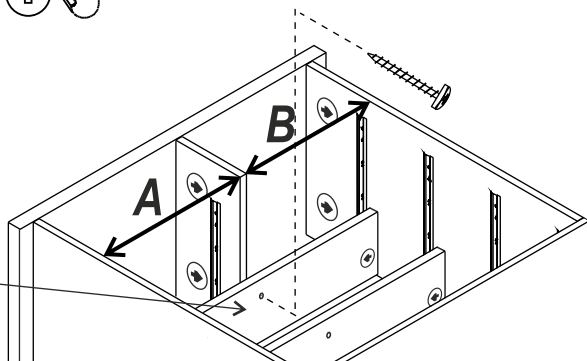
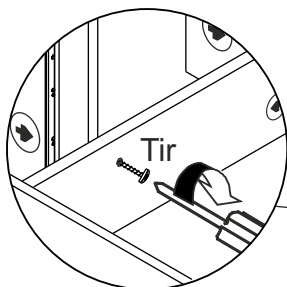

7

Pun x 30

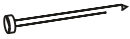

Rei x 16



Pata x 4



Cinta americana

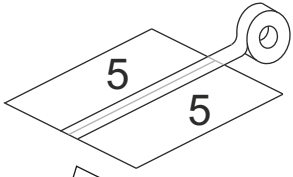
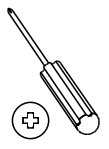

*Las traseras deben quedar bien escuadradas
Las diagonales deben medir igual*

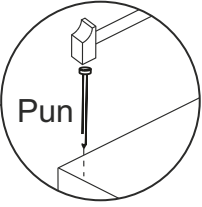
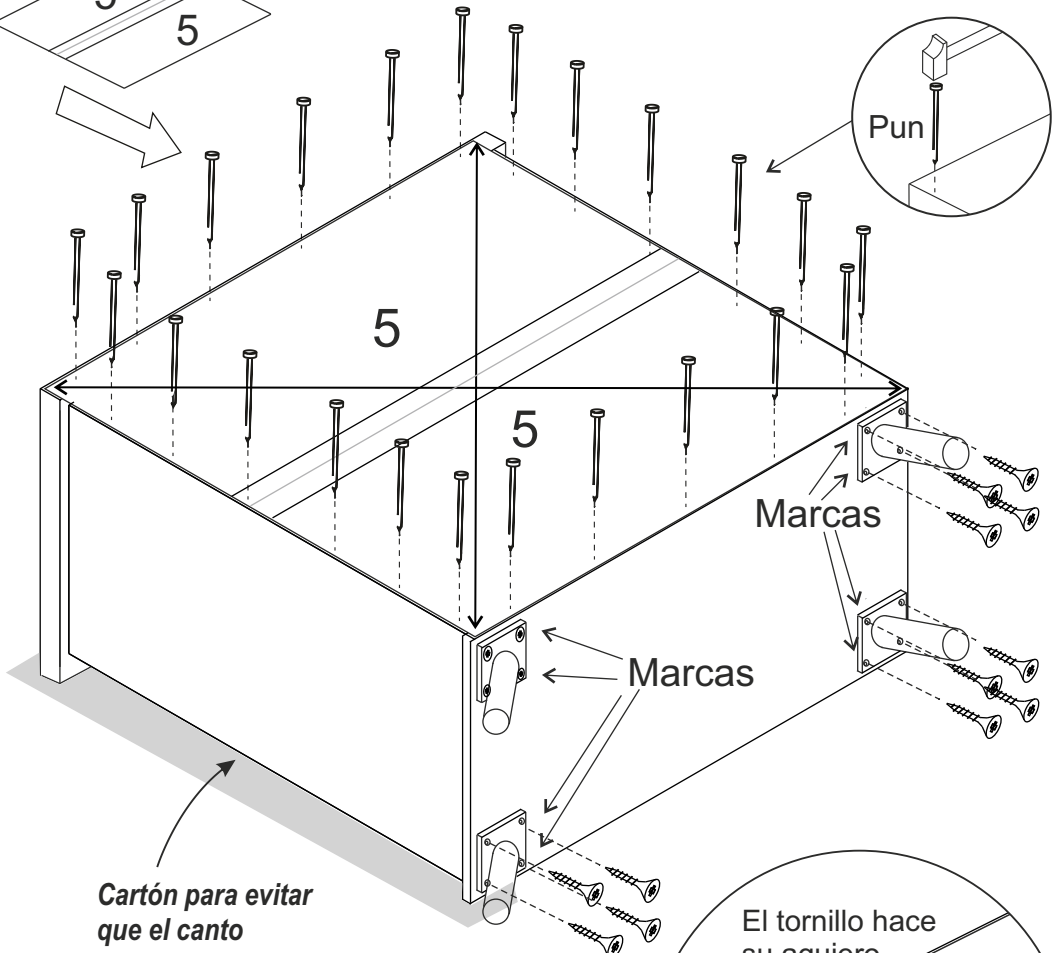

Marcas

Marcas

*Cartón para evitar
que el canto
se estropee*

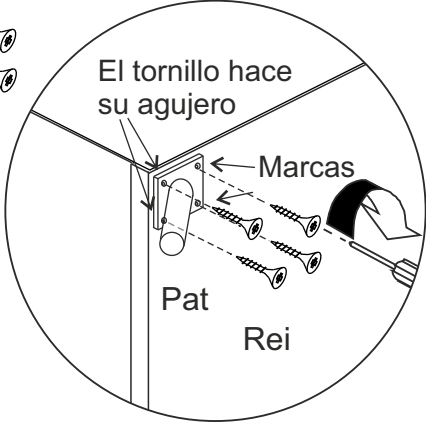

El tornillo hace su agujero

Marcas

Pat

Rei

8

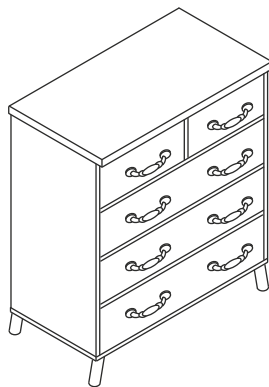
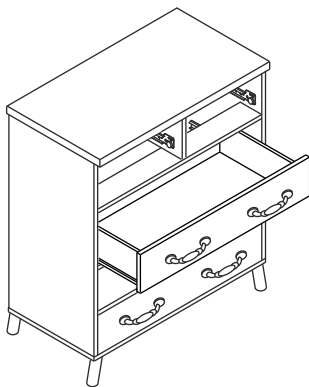
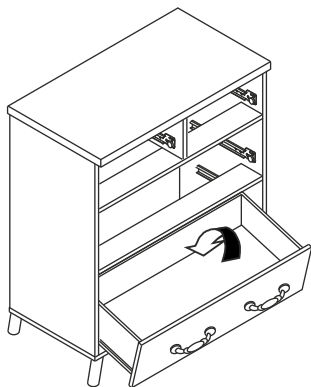

CONDICIONES DE USO Y MANTENIMIENTO

Producto de uso doméstico.

Evitar colocar el mueble cerca de fuentes de calor, de humedad o de una fuerte luz solar.

No lo limpie con productos abrasivos, ni disolventes.

Quitar el polvo antes de limpiarlo.

Utilizar un paño húmedo, limpio y sin pelos.

CONDIÇÕES DE USO E MANUTENÇÃO DO MÓVEL

Produto de uso doméstico.

Evitar colocar o móvel próximo a fontes de calor, de humidade ou exposto a luz solar intensa.

Não limpar com produtos abrasivos ou produtos de limpeza com solvente.

Eliminar o pó antes de qualquer processo de limpeza.

É recomendável utilizar um pano húmido, limpo e sem pelos.

ATENCIÓN AL CLIENTE

(+34) 966 422 117

HORARIO: 8:00h a 15:00h de lunes a viernes
www.ohcielos.com - info@ohcielos.com

LOTE 5109