

# Mesa despacho Eko

Instrucciones de montaje



# Te aconsejamos

Ordena y cuenta las piezas y herramientas

Habilita una zona para el montaje



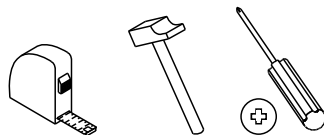

No fuerces los tornillos y los elementos de montaje

Sigue paso a paso las instrucciones de montaje

## Las herramientas que necesitas (no incluidas)

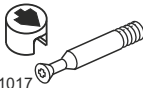

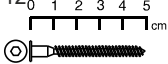
## Los herrajes que encontrarás en el kit

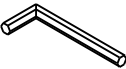
Exc x 6 Nº721016/721017		G33 x 4 Nº710049		Lzgr x 1 Nº721034		Autgr x 12 Nº721002	
Tac x 6 Nº721045		Lzpq x 1 Nº710251					

## Bolsa para los cajones

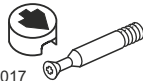
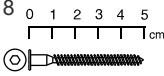
Excpcq x 8 Nº721126/721017		Autpcq x 8 Nº710250	
-------------------------------	---	------------------------	---

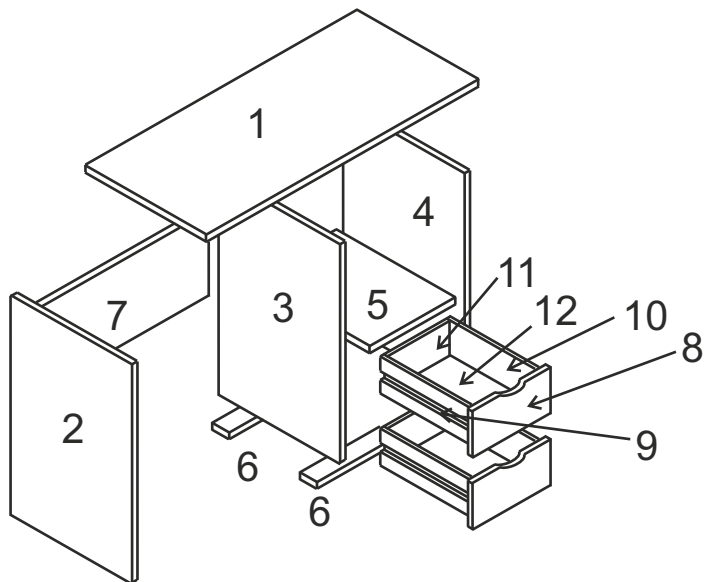

## Las piezas incluidas en el kit



**1**  
Tapa  
1150x500 mm  
100531/600531



**2**  
Lateral izqdo  
740x450 mm  
100515/600515

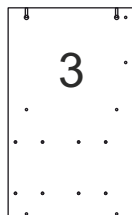

**3**  
Centro  
740x450 mm  
100550/600550

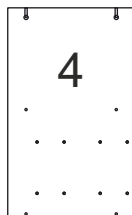

**4**  
Lateral drcho  
740x450 mm  
100514/60514



**5**  
Balda  
446x362 mm  
100520/600520

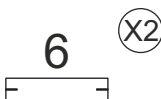

**6** (X2)  
Tarima  
362x80 mm  
1005770/600570



**7**  
Pieza trasera  
700x224 mm  
100575/600575

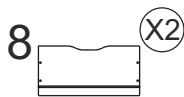

**8** (X2)  
Frente cajón  
359x176 mm  
100560/600560

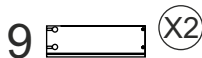

**9** (X2)  
**10** (X2)  
Costillas laterales  
350x110 mm  
1350115/1350116



**11** (X2)  
Costilla fondo  
333x110 mm  
1333119

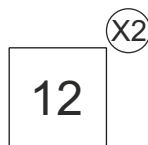

**12** (X2)  
Fondo cajón  
350x345 mm  
8100574

### CONDICIONES DE USO Y MANTENIMIENTO

Producto de uso doméstico.

Evitar colocar el mueble cerca de fuentes de calor, de humedad o de una fuerte luz solar.

No lo limpie con productos abrasivos, ni disolventes.

Quitar el polvo antes de limpiarlo.

Utilizar un paño húmedo, limpio y sin pelos.

### CONDIÇÕES DE USO E MANUTENÇÃO DO MÓVEL

Produto de uso doméstico.

Evitar colocar o móvel próximo a fontes de calor, de humidade ou exposto a luz solar intensa.

Não limpar com produtos abrasivos ou produtos de limpeza com solvente.

Eliminar o pó antes de qualquer processo de limpeza.

É recomendável utilizar um pano húmido, limpo e sem pelos.

### ATENCIÓN AL CLIENTE

**(+34) 966 422 117**

HORARIO: 8:00h a 15:00h de lunes a viernes  
[www.ohcielos.com](http://www.ohcielos.com) - [info@ohcielos.com](mailto:info@ohcielos.com)

**LOTE 5314/5315**

# 1

## El primer paso es el montaje de los herrajes

Exc x 6



Tac x 6



G33 x 4

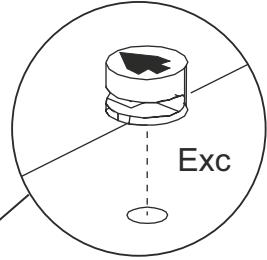
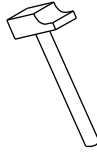

Exc

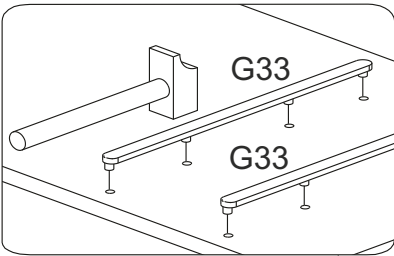

G33

G33

3

4

2

Tac

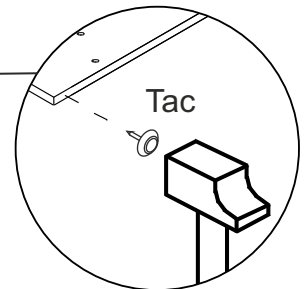

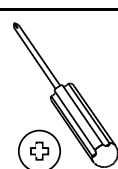
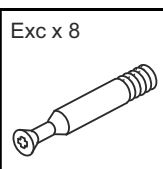
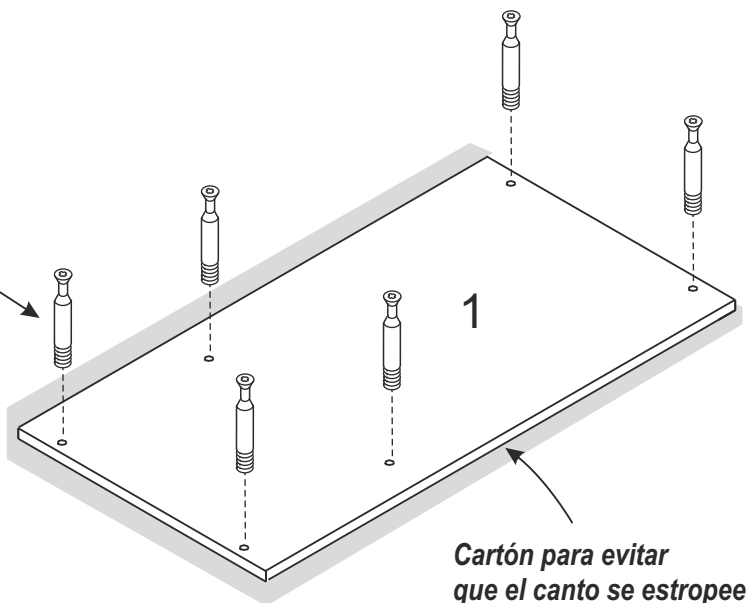
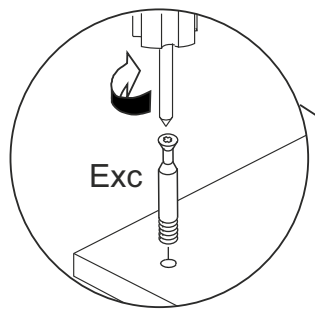
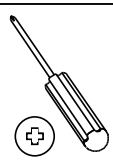
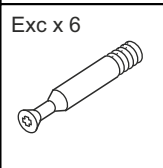

Bolsa para los cajones

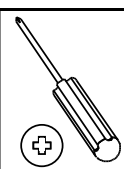
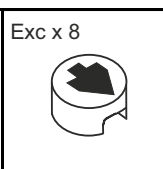
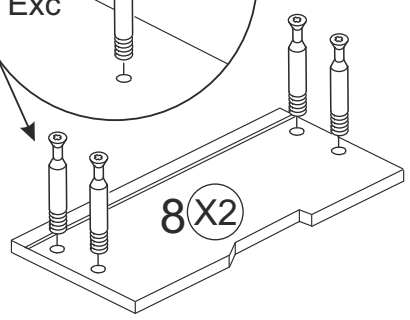
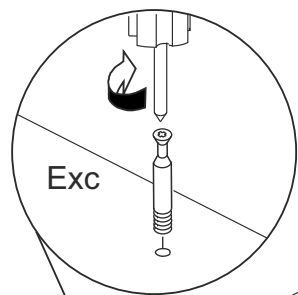

Bolsa para los cajones

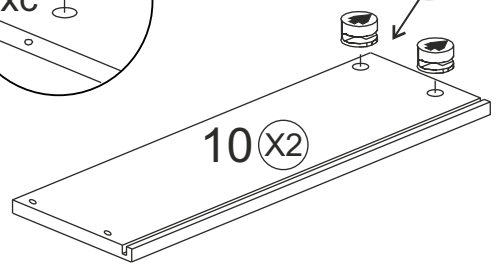
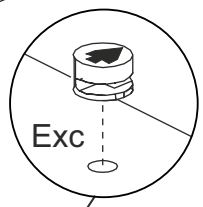
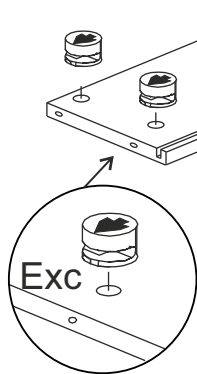

# 2

Autpq x 8



Lzpq x 1

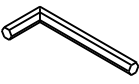

Los 2 cajones se montan igual

Bolsa para los cajones

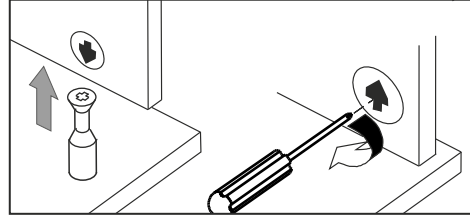
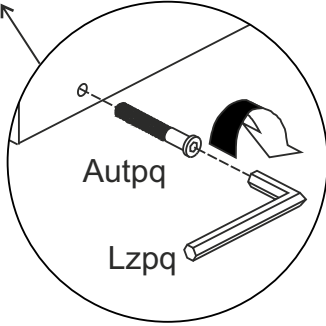
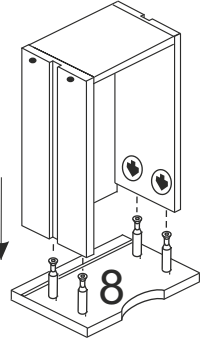
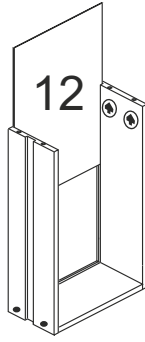
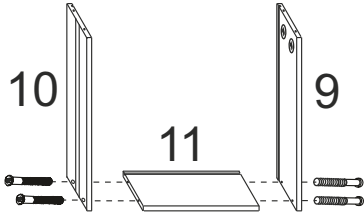

# 3

Autgr x 8



Lzgr x 1

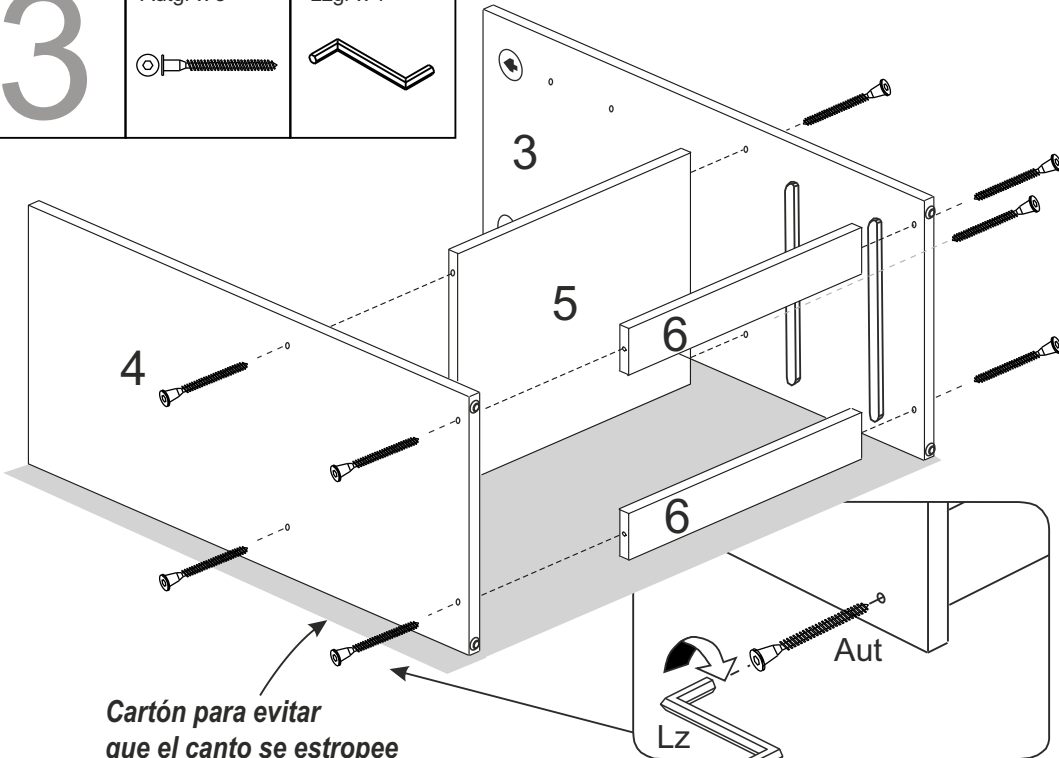
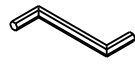

*Cartón para evitar que el canto se estropee*

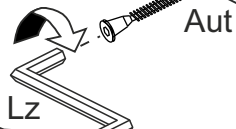

4

Autgr x 4



Lzgr x 1

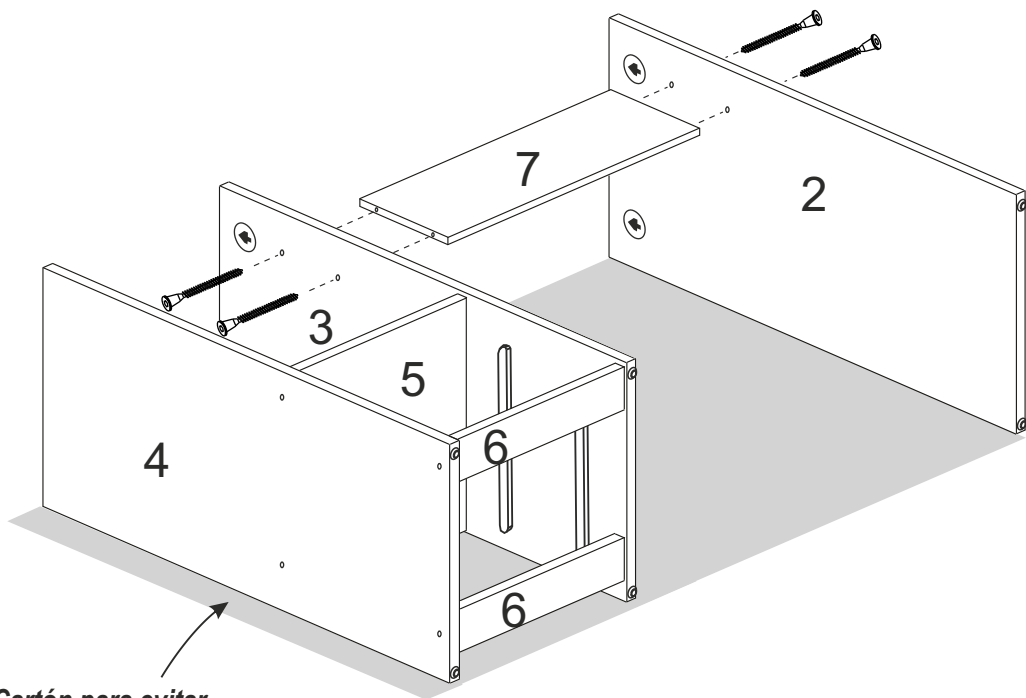
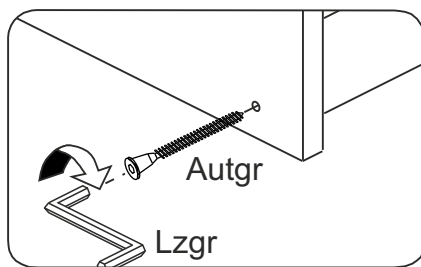

*Cartón para evitar que el canto se estropee*

# 5

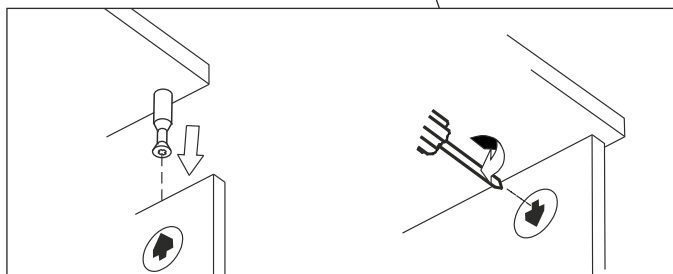
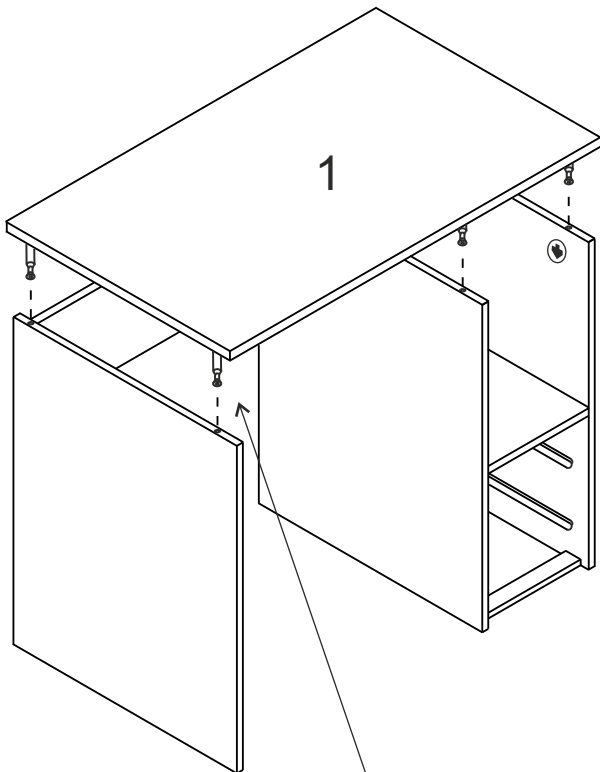
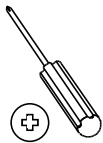

# 6

